

## Fibox SOLID

SOLID range is an excellent choice to house electronic and electrical components. It is also an ideal alternative to polyester enclosures. It is available with screw and hinge covers in both polycarbonate and ABS.

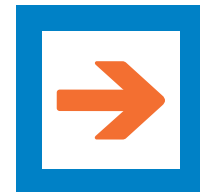

# SOLID



Wide opening hinges



Wide accessory selection



RoHS compliant and halogen-free

# SOLID PC/ABS 1919

188 x 188 PC: IP 66/IP 67, IK 08/IK 09  
ABS: IP 66/IP 67, IK 08

Including: Base with screws for mounting plate/DIN-rail, cover with PUR gasket and polyamide cover screws.



## Enclosures

Order symbol	Code	Dimensions	Description
PC 1919 13 G	5330359	188 x 188 x 130	Enclosure, PC • Grey cover
PC 1919 18 G	5330369	188 x 188 x 180	Enclosure, PC • Grey cover
PC 1919 13 G-2FSH	2539505	188 x 188 x 130	Enclosure, PC, IP 65 • Grey hinged cover
PC 1919 18 G-2FSH	2539507	188 x 188 x 180	Enclosure, PC, IP 65 • Grey hinged cover
PC 1919 13 T	5330059	188 x 188 x 130	Enclosure, PC • Transparent cover
PC 1919 18 T	5330069	188 x 188 x 180	Enclosure, PC • Transparent cover
PC 1919 13 T-2FSH	2539535	188 x 188 x 130	Enclosure, PC, IP 65 • Transparent hinged cover
PC 1919 18 T-2FSH	2539537	188 x 188 x 180	Enclosure, PC, IP 65 • Transparent hinged cover
ABS 1919 13 G	5880359	188 x 188 x 130	Enclosure, ABS • Grey cover
ABS 1919 18 G	5880369	188 x 188 x 180	Enclosure, ABS • Grey cover
ABS 1919 13 G-2FSH	9880401	188 x 188 x 130	Enclosure, ABS, IP 65 • Grey hinged cover
ABS 1919 18 G-2FSH	9880405	188 x 188 x 180	Enclosure, ABS, IP 65 • Grey hinged cover
ABS 1919 13 T	5880059	188 x 188 x 130	Enclosure, ABS • Transparent cover
ABS 1919 18 T	5880069	188 x 188 x 180	Enclosure, ABS • Transparent cover
ABS 1919 13 T-2FSH	9880451	188 x 188 x 130	Enclosure, ABS, IP 65 • Transparent hinged cover
ABS 1919 18 T-2FSH	9880455	188 x 188 x 180	Enclosure, ABS, IP 65 • Transparent hinged cover

## Accessories

Order symbol	Code	Dimensions	Description
EKHVT	3770548	148 x 148	Mounting plate
EKV 12	3770647	35 x 160	DIN-35 Mounting rail

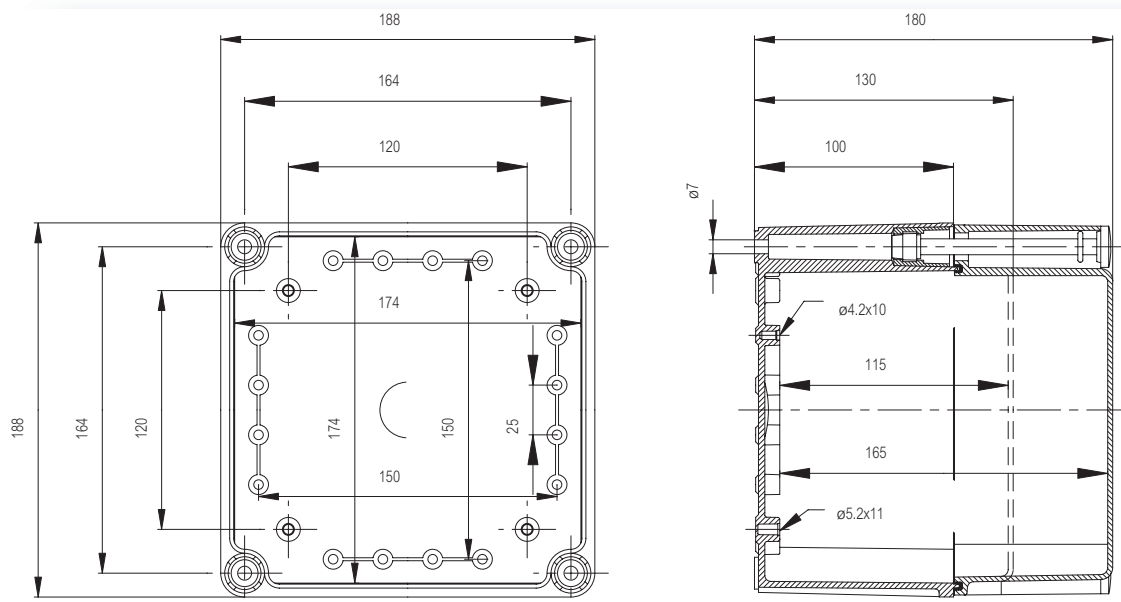



## SOLID PC/ABS 2819

278 x 188 PC: IP 66/IP 67, IK 08/IK 09  
ABS: IP 66/IP 67, IK 08

Including: Base with screws for mounting plate/DIN-rail, cover with PUR gasket and polyamide cover screws.

### Enclosures

Order symbol	Code	Dimensions	Description
PC 2819 13 G	5330360	278 x 188 x 130	Enclosure, PC • Grey cover
PC 2819 18 G	5330370	278 x 188 x 180	Enclosure, PC • Grey cover
PC 2819 13 G-2FSH	2539509	278 x 188 x 130	Enclosure, PC, IP 65 • Grey hinged cover
PC 2819 18 G-2FSH	2539511	278 x 188 x 180	Enclosure, PC, IP 65 • Grey hinged cover
PC 2819 13 T	5330060	278 x 188 x 130	Enclosure, PC • Transparent cover
PC 2819 18 T	5330070	278 x 188 x 180	Enclosure, PC • Transparent cover
PC 2819 13 T-2FSH	2539539	278 x 188 x 130	Enclosure, PC, IP 65 • Transparent hinged cover
PC 2819 18 T-2FSH	2539541	278 x 188 x 180	Enclosure, PC, IP 65 • Transparent hinged cover
ABS 2819 13 G	5880360	278 x 188 x 130	Enclosure, ABS • Grey cover
ABS 2819 18 G	5880370	278 x 188 x 180	Enclosure, ABS • Grey cover
ABS 2819 13 G-2FSH	9996267	278 x 188 x 130	Enclosure, ABS, IP 65 • Grey hinged cover
ABS 2819 18 G-2FSH	9996268	278 x 188 x 180	Enclosure, ABS, IP 65 • Grey hinged cover
ABS 2819 13 T	5880060	278 x 188 x 130	Enclosure, ABS • Transparent cover
ABS 2819 18 T	5880070	278 x 188 x 180	Enclosure, ABS • Transparent cover
ABS 2819 13 T-2FSH	9880459	278 x 188 x 130	Enclosure, ABS, IP 65 • Transparent hinged cover
ABS 2819 18 T-2FSH	9880463	278 x 188 x 180	Enclosure, ABS, IP 65 • Transparent hinged cover

### Accessories

Order symbol	Code	Dimensions	Description
EKJVT	3770549	238 x 148	Mounting plate
EKV 12	3770647	35 x 160	DIN-35 Mounting rail
EKV 22	3770648	35 x 235	DIN-35 Mounting rail
EKJZR	3730153	278 x 188 x 50	Extension frame

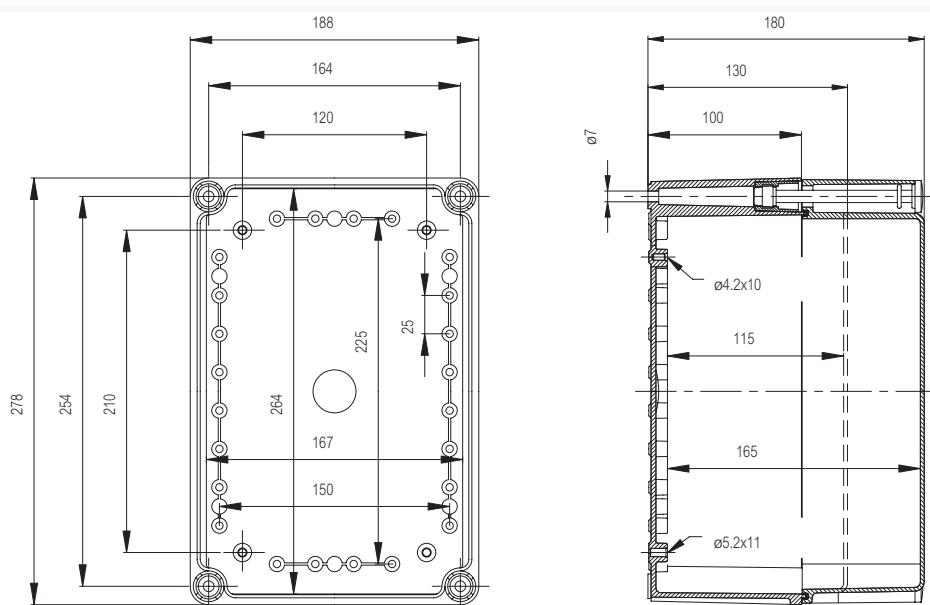

# SOLID PC/ABS 3819

378 x 188 PC: IP 66/IP 67, IK 08/IK 09  
ABS: IP 66/IP 67, IK 08

Including: Base with screws for mounting plate/DIN-rail, cover with PUR gasket and polyamide cover screws.



## Enclosures

Order symbol	Code	Dimensions	Description
PC 3819 13 G	5330361	378 x 188 x 130	Enclosure, PC • Grey cover
PC 3819 18 G	5330371	378 x 188 x 180	Enclosure, PC • Grey cover
PC 3819 13 G-2FSH	2539513	378 x 188 x 130	Enclosure, PC, IP 65 • Grey hinged cover
PC 3819 18 G-2FSH	2539515	378 x 188 x 180	Enclosure, PC, IP 65 • Grey hinged cover
PC 3819 13 T	5330061	378 x 188 x 130	Enclosure, PC • Transparent cover
PC 3819 18 T	5330071	378 x 188 x 180	Enclosure, PC • Transparent cover
PC 3819 13 T-2FSH	2539543	378 x 188 x 130	Enclosure, PC, IP 65 • Transparent hinged cover
PC 3819 18 T-2FSH	2539545	378 x 188 x 180	Enclosure, PC, IP 65 • Transparent hinged cover
ABS 3819 13 G	5880361	378 x 188 x 130	Enclosure, ABS • Grey cover
ABS 3819 18 G	5880371	378 x 188 x 180	Enclosure, ABS • Grey cover
ABS 3819 13 G-2FSH	9880425	378 x 188 x 130	Enclosure, ABS, IP 65 • Grey hinged cover
ABS 3819 18 G-2FSH	9880429	378 x 188 x 180	Enclosure, ABS, IP 65 • Grey hinged cover
ABS 3819 13 T	5880061	378 x 188 x 130	Enclosure, ABS • Transparent cover
ABS 3819 18 T	5880071	378 x 188 x 180	Enclosure, ABS • Transparent cover
ABS 3819 13 T-2FSH	9880475	378 x 188 x 130	Enclosure, ABS, IP 65 • Transparent hinged cover
ABS 3819 18 T-2FSH	9880479	378 x 188 x 180	Enclosure, ABS, IP 65 • Transparent hinged cover

## Accessories

Order symbol	Code	Dimensions	Description
EKMVT	3770550	338 x 148	Mounting plate
EKV 12	3770647	35 x 160	DIN-35 Mounting rail
EKV 32	3770649	35 x 335	DIN-35 Mounting rail
EKMZR	3730152	378 x 188 x 50	Extension frame

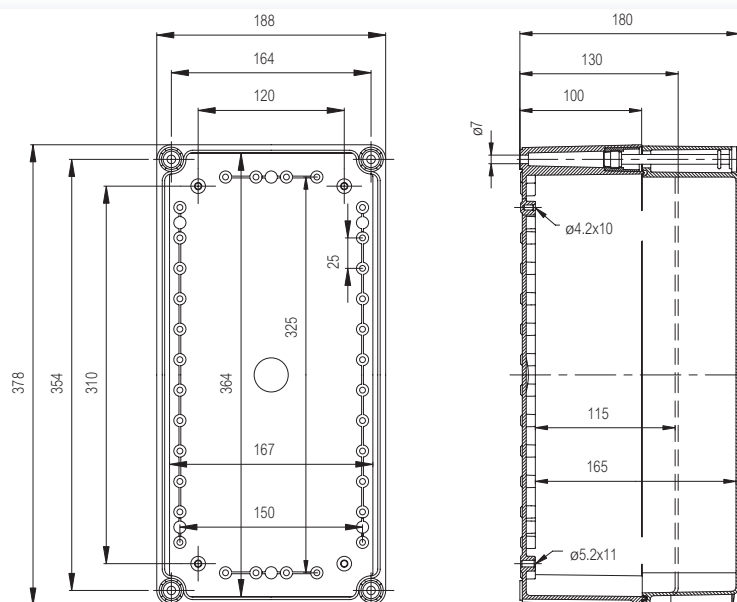



## SOLID PC/ABS 2828

278 x 278 PC: IP 66/IP 67, IK 08/IK 09  
ABS: IP 66/IP 67, IK 08

Including: Base with screws for mounting plate/DIN-rail, cover with PUR gasket and polyamide cover screws.

### Enclosures

Order symbol	Code	Dimensions	Description
PC 2828 13 G	5330362	278 x 278 x 130	Enclosure, PC • Grey cover
PC 2828 18 G	5330372	278 x 278 x 180	Enclosure, PC • Grey cover
PC 2828 13 G-2FSH	2539517	278 x 278 x 130	Enclosure, PC, IP 65 • Grey hinged cover
PC 2828 18 G-2FSH	2539519	278 x 278 x 180	Enclosure, PC, IP 65 • Grey hinged cover
PC 2828 13 T	5330062	278 x 278 x 130	Enclosure, PC • Transparent cover
PC 2828 18 T	5330072	278 x 278 x 180	Enclosure, PC • Transparent cover
PC 2828 13 T-2FSH	2539547	278 x 278 x 130	Enclosure, PC, IP 65 • Transparent hinged cover
PC 2828 18 T-2FSH	2539549	278 x 278 x 180	Enclosure, PC, IP 65 • Transparent hinged cover
ABS 2828 13 G	5880362	278 x 278 x 130	Enclosure, ABS • Grey cover
ABS 2828 18 G	5880372	278 x 278 x 180	Enclosure, ABS • Grey cover
ABS 2828 13 G-2FSH	9880417	278 x 278 x 130	Enclosure, ABS, IP 65 • Grey hinged cover
ABS 2828 18 G-2FSH	9880421	278 x 278 x 180	Enclosure, ABS, IP 65 • Grey hinged cover
ABS 2828 13 T	5880062	278 x 278 x 130	Enclosure, ABS • Transparent cover
ABS 2828 18 T	5880072	278 x 278 x 180	Enclosure, ABS • Transparent cover
ABS 2828 13 T-2FSH	9880467	278 x 278 x 130	Enclosure, ABS, IP 65 • Transparent hinged cover
ABS 2828 18 T-2FSH	9880471	278 x 278 x 180	Enclosure, ABS, IP 65 • Transparent hinged cover

### Accessories

Order symbol	Code	Dimensions	Description
EKOVT	3770551	238 x 238	Mounting plate
EKV 22	3770648	35 x 235	DIN-35 Mounting rail
EKOZR	3730093	278 x 278 x 50	Extension frame

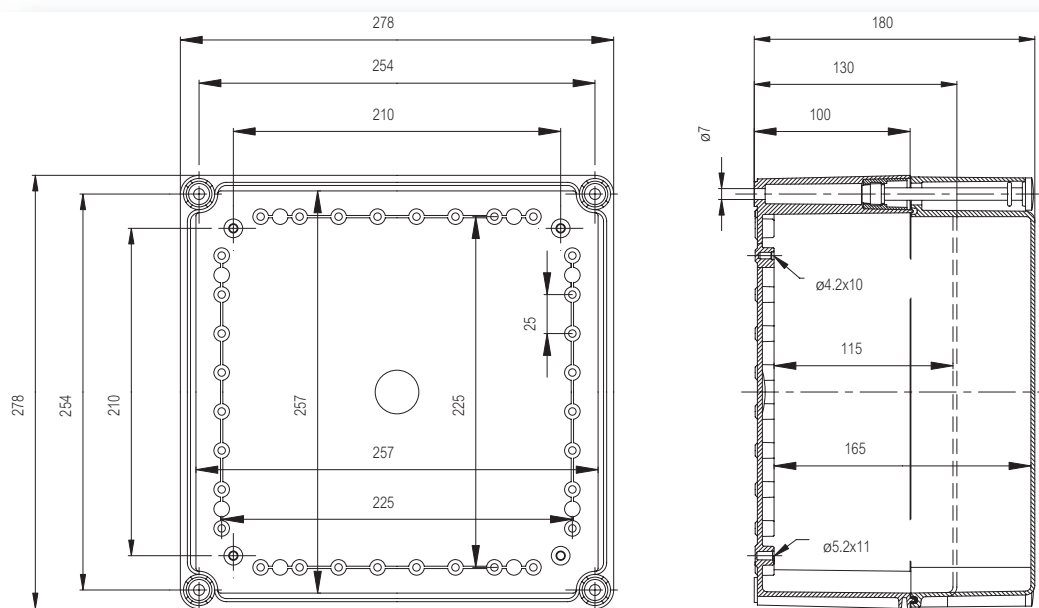

# SOLID PC/ABS 3828

378 x 278 PC: IP 66/IP 67, IK 08/IK 09  
ABS: IP 66/IP 67, IK 08

Including: Base with screws for mounting plate/DIN-rail, cover with PUR gasket and polyamide cover screws.



## Enclosures

Order symbol	Code	Dimensions	Description
PC 3828 13 G	5330363	378 x 278 x 130	Enclosure, PC • Grey cover
PC 3828 18 G	5330373	378 x 278 x 180	Enclosure, PC • Grey cover
PC 3828 13 G-2FSH	2539521	378 x 278 x 130	Enclosure, PC, IP 65 • Grey hinged cover
PC 3828 18 G-2FSH	2539523	378 x 278 x 180	Enclosure, PC, IP 65 • Grey hinged cover
PC 3828 13 T	5330063	378 x 278 x 130	Enclosure, PC • Transparent cover
PC 3828 18 T	5330073	378 x 278 x 180	Enclosure, PC • Transparent cover
PC 3828 13 T-2FSH	2539551	378 x 278 x 130	Enclosure, PC, IP 65 • Transparent hinged cover
PC 3828 18 T-2FSH	2539553	378 x 278 x 180	Enclosure, PC, IP 65 • Transparent hinged cover
ABS 3828 13 G	5880363	378 x 278 x 130	Enclosure, ABS • Grey cover
ABS 3828 18 G	5880373	378 x 278 x 180	Enclosure, ABS • Grey cover
ABS 3828 13 G-2FSH	9996276	378 x 278 x 130	Enclosure, ABS, IP 65 • Grey hinged cover
ABS 3828 18 G-2FSH	9996275	378 x 278 x 180	Enclosure, ABS, IP 65 • Grey hinged cover
ABS 3828 13 T	5880063	378 x 278 x 130	Enclosure, ABS • Transparent cover
ABS 3828 18 T	5880073	378 x 278 x 180	Enclosure, ABS • Transparent cover
ABS 3828 13 T-2FSH	9996269	378 x 278 x 130	Enclosure, ABS, IP 65 • Transparent hinged cover
ABS 3828 18 T-2FSH	9996270	378 x 278 x 180	Enclosure, ABS, IP 65 • Transparent hinged cover

## Accessories

Order symbol	Code	Dimensions	Description
EKPVT	3770552	338 x 238	Mounting plate
EKV 22	3770648	35 x 235	DIN-35 Mounting rail
EKV 32	3770649	35 x 335	DIN-35 Mounting rail
EKPZR	3730141	378 x 278 x 50	Extension frame

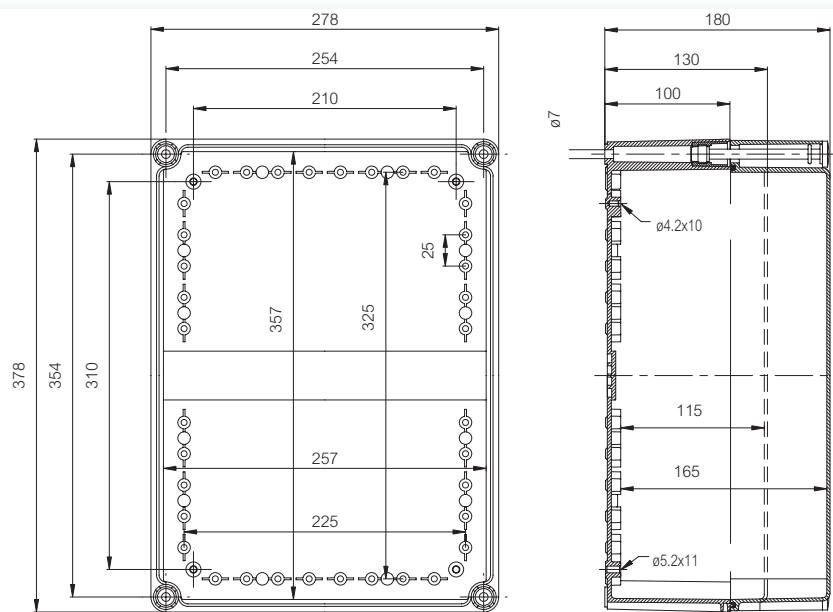



## SOLID PC/ABS 5628

558 x 278 PC: IP 66/IP 67, IK 08/IK 09  
ABS: IP 66/IP 67, IK 08

Including: Base with screws for mounting plate/DIN-rail, cover with PUR gasket and polyamide cover screws.

### Enclosures

Order symbol	Code	Dimensions	Description
PC 5628 13 G	5330364	558 x 278 x 130	Enclosure, PC • Grey cover
PC 5628 13 G-3FSH	2539525	558 x 278 x 130	Enclosure, PC, IP 65 • Grey hinged cover
PC 5628 13 T	5330064	558 x 278 x 130	Enclosure, PC • Transparent cover
PC 5628 13 T-3FSH	2539555	558 x 278 x 130	Enclosure, PC, IP 65 • Transparent hinged cover
ABS 5628 13 G	5880364	558 x 278 x 130	Enclosure, ABS • Grey cover
ABS 5628 13 G-3FSH	9880441	558 x 278 x 130	Enclosure, ABS, IP 65 • Grey hinged cover
ABS 5628 13 T	5880064	558 x 278 x 130	Enclosure, ABS • Transparent cover
ABS 5628 13 T-3FSH	9996271	558 x 278 x 130	Enclosure, ABS, IP 65 • Transparent hinged cover

### Accessories

Order symbol	Code	Dimensions	Description
EKTVT	3770553	518 x 238	Mounting plate
EKV 22	3770648	35 x 235	DIN-35 Mounting rail
EKV 50	3770699	35 x 500	DIN-35 Mounting rail
EKTZR	3730142	558 x 278 x 50	Extension frame

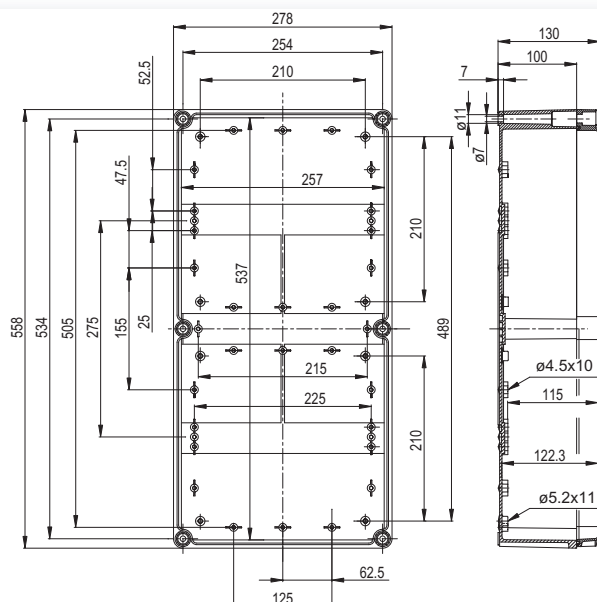

# SOLID PC/ABS 5638

558 x 378 PC: IP 66/IP 67, IK 08/IK 09  
ABS: IP 66/IP 67, IK 08

Including: Base with screws for mounting plate/DIN-rail, cover with PUR gasket and polyamide cover screws.



## Enclosures

Order symbol	Code	Dimensions	Description
PC 5638 18 G	5330365	558 x 378 x 180	Enclosure, PC • Grey cover
PC 5638 18 G-3FSH	2539527	558 x 378 x 180	Enclosure, PC, IP 65 • Grey hinged cover
PC 5638 18 T	5330065	558 x 378 x 180	Enclosure, PC • Transparent cover
PC 5638 18 T-3FSH	2539557	558 x 378 x 180	Enclosure, PC, IP 65 • Transparent hinged cover
ABS 5638 18 G	5880365	558 x 378 x 180	Enclosure, ABS • Grey cover
ABS 5638 18 G-3FSH	9880445	558 x 378 x 180	Enclosure, ABS, IP 65 • Grey hinged cover
ABS 5638 18 T	5880065	558 x 378 x 180	Enclosure, ABS • Transparent cover
ABS 5638 18 T-3FSH	9996272	558 x 378 x 180	Enclosure, ABS, IP 65 • Transparent hinged cover

## Accessories

Order symbol	Code	Dimensions	Description
EKUVT	3770554	518 x 338	Mounting plate
EKV 32	3770649	35 x 335	DIN-35 Mounting rail
EKUZR	3730323	558 x 378 x 50	Extension frame

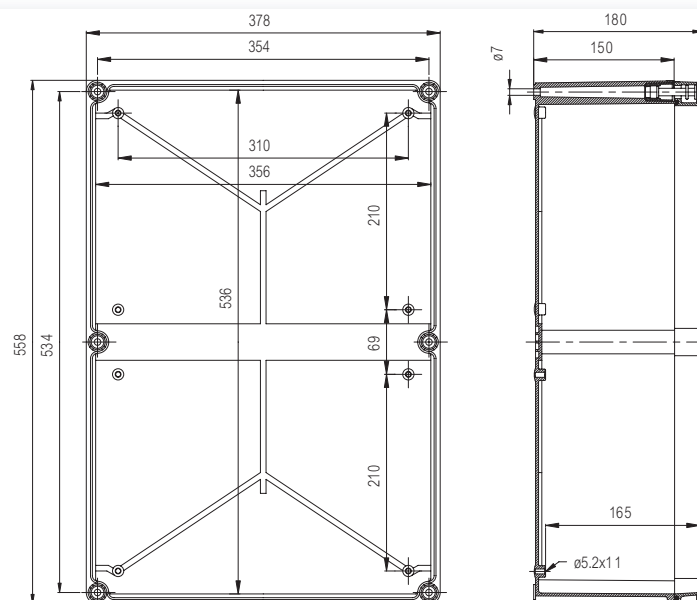



## ACCESSORIES

Order symbol      Code      Description

### Mounting plates (Galvanized steel, sheet thickness 1,5 mm)

EKHVT	3770548	148 x 148
EKJVT	3770549	238 x 148
EKMVT	3770550	338 x 148
EKOVT	3770551	238 x 238
EKPVT	3770552	338 x 238
EKTVT	3770553	518 x 238
EKUVT	3770554	518 x 338

### Mounting plates for kWh-meter

EKPVM2	3770839	338 x 238 • for kWh-meter
EKPVM2P	3771839	338 x 238 • for kWh-meter (polyester)
M6x16	3570678	Mounting screw • for mounting the kWh meter

### DIN-35 Mounting rails (Galvanized steel, rail height 7,5 mm)

EKV 12	3770647	35 x 160
EKV 22	3770648	35 x 235
EKV 32	3770649	35 x 335
EKV 50	3770699	35 x 500

### Mounting rail accessories

MSM PT 5x10	4712049	Mounting screw
MB 10686	3730686	Set of 2 spacers including screws • (15/34 mm)

### DIN rail frames

MS PROF 19	3510840	DIN rail frames
MS PROF 28	3510841	DIN rail frames
MS PROF 38	3510842	DIN rail frames
MS PROF 56	3510843	DIN rail frames
EKT PROF 56	3510844	DIN terminal rail

### Extension frames (Polycarbonate, PUR Gasket)

EKJZR	3730153	278 x 188 x 50
EKMZR	3730152	378 x 188 x 50
EKOZR	3730093	278 x 278 x 50
EKPZR	3730141	378 x 278 x 50
EKTZR	3730142	558 x 278 x 50
EKUZR	3730323	558 x 378 x 50

### Front plates with DIN-openings

FP12-2819	3770765	280 x 190 • 12 modules
FP12-2828	3770756	280 x 280 • 12 modules
FP12x2-2828	3770766	280 x 280 • 2x12 modules
FP12x2-2838	3770769	280 x 380 • 2x12 modules
FP12x3-2838	3770767	280 x 380 • 3x12 modules
FP12x3-2856	3770768	280 x 560 • 3x12 modules

### MB FP88 and MB FP882 spacers

MB FP88	3530764	Distance spacer for front plates
MB FP882	3530771	Distance spacer for front plates
MB 26050	5026050	Cover plate for 12 modules • (1 module = 17,5 mm)
MB 26069SET	5126029	N/PE terminal bracket set • incl. 2 pcs of terminals (16-holes)
MS BAR CLAMP	4712232	Terminal bus-bar clamp, 25 mm <sup>2</sup>
MR 26145	5026145	Terminal bus-bar clamp, 35 mm <sup>2</sup>

### PC front plates for FX20 SET

FX FP 8-2819	3770849	280 x 190 • Blue, thickness 2 mm
FX FP 12-2828	3770850	280 x 280 • Blue, thickness 2 mm
FX FP 2*12-2838	3770851	380 x 280 • Blue, thickness 2 mm
FX FP 3*12-2856	3770852	560 x 280 • Blue, thickness 2 mm



## ACCESSORIES

Order symbol      Code      Description

### Corner stud FX20 SET

FX20 SET	3570791	Corner stud set (4 pcs) • incl. screws
MB 10791	3730791	Corner stud (separate)
MB 10792	3730792	Front plate screw
MS BAR 2+18	4712199	PE/N terminal bus-bar 25+ 10 mm <sup>2</sup>

### PC front plates for MB 60MM bus-bar holder

MB FP 2828	3770853	Blue, thickness 2 mm
MB FP 3828	3770854	Blue, thickness 2 mm
MB FP 5628	3770855	Blue, thickness 2 mm

### 60 MM Bus-Bar

MB 60MM	3532385	Bus-bar holder set • incl. screws and support
MB 10792	3730792	Front plate screw

### Hinges and wall mounting

MB 10622	3530622	PC Hinge set, 1 pair • incl. screws and drill template
MB 10547	3570547	PA Hinge set, 1 pair • incl. screws
EKZKS 1	3570570	Hinge set, metal
MB 10523	3560523	Blind plug for cover corner on hinged side when cover screws are not used
MB 10674	3770674	Wall fastening lug (4 pcs) • incl. screws

### Cover screws

HS 10255	3540255	Wing head • for 30 mm cover
CS 10256	3540256	Cross head • for 30/100 mm cover
SS 10535	3540535	Slotted head (sealable) • for 30 mm cover
SS 10544	3570544	Slotted head (quick-lock) • for 30/100 mm cover
HS 10533	3570533	Wing head (quick-lock) • for 30 mm cover
HS 10532	3570532	Quick-locking wing head (hinged) • for 30 mm cover
MB 10534	3540534	Threaded bushing • to be ordered separately with quick-lock screws
SS 10563	3540563	Cross head • for 80 mm cover
HS 10562	3540562	Wing head • for 80 mm cover
DS 10581	3540581	Triangle head • for 30/80/100 mm cover
MB 10673 SET	3570673	Triangular key • for cover screw DS 10581
SS 10256 N	3510256	Slotted head, Noryl (good chemical resistance) • for 30 mm cover
HS 10255 N	3510255	Wing head, Noryl (good chemical resistance) • for 30 mm cover
SS 10256-4	3544256	Set of 4 cross head screws • for 30/100 mm cover
SS 10256-6	3546256	Set of 6 cross head screws • for 30/100 mm cover
SS 10563-4	3544563	Set of 4 cross head screws • for 80 mm cover

### Spacers for corners of the base

MR 10726	5070726	Spacer 15 mm • M6 self-cutting
MR 10727	5070727	Spacer 20 mm • M6 self-cutting
MR 10728	5070728	Spacer 30 mm • M6 self-cutting
MR 10729	5070729	Spacer 54 mm • M6 self-cutting
HR 10	3570655	Extension for MR spacer • 10 mm, M6/M6
HR 15	3570656	Extension for MR spacer • 15 mm, M6/M6
HR 20	3570657	Extension for MR spacer • 20 mm, M6/M6
HR 30	3570658	Extension for MR spacer • 30 mm, M6/M6

### Spacers for middle mounting pods

FA 12053	4712053	Spacer 14 mm • M5 self-cutting
FA 12052	4712052	Spacer 42 mm • M5 self-cutting

### Key-Lock Set

MB 10597	3570597	Lock and two keys • For 30mm covers only
----------	---------	--



## SOLID technical information

Property	Polycarbonate (PC)	ABS	Confirmity to standards
Ingress Protection (EN 60529)	IP 66/IP 67 IP 65 (FSH)	IP 66/IP 67 IP 65 (FSH)	
Impact Resistance (EN 62262)	IK 08 (side surface) IK 09 (front surface)	IK 08	
Temperature Range Celsius (short term) Fahrenheit	-40° . . .120°C -40° . . .250°F	-40° . . .80°C -40° . . .175°F	
Temperature Range Celsius (continuous) Fahrenheit	-40° . . .80°C -40° . . .175°F	-40° . . .60°C -40° . . .140°F	
Electrical Insulation	Totally insulated ☐	Totally insulated ☐	
Light Grey Parts Colour	RAL 7035 Industry Grey	RAL 7035 Industry Grey	
Transparent Clear PC Cover	Clear transparent	Clear transparent	
Cover Screws	RAL 7035	RAL 7035	
Cover Screws	Polyamide (PA)	Polyamide (PA)	
Gasket	PUR	PUR	
Enclosure Flammability Rating	UL 94-5V	UL 94HB	
Glow Wire Test (IEC 695-2-1) Self -extinguishing (PC)	960°C	650°C	
Non-toxicity	Halogen Free	Halogen Free	
UV resistance	UL 508 720 hours in "Weather- ometer"		
Chemical Resistance *	Good	Good	

Data subject to change without notice.

\* Consult separate raw material data for more detailed information



**FIBOX – Solutions for demanding environments**

